

Varenummer: 03351025  
 Beskrivelse: Fluro ledhoved GAXSW 25MS

## Mål

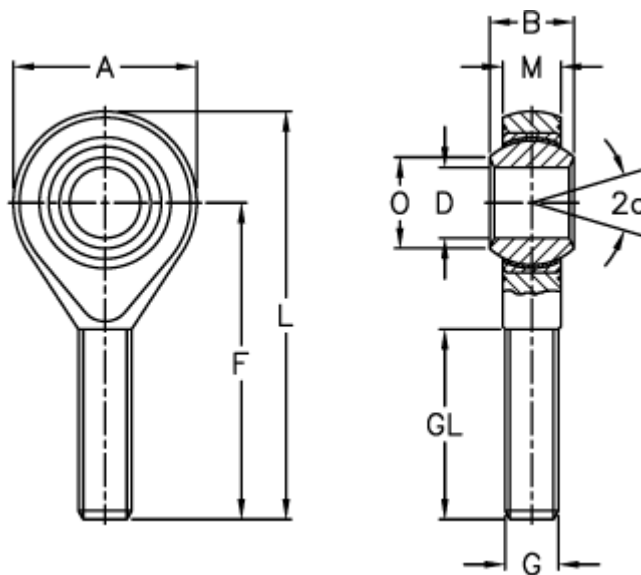

A	= 60	L	= 124
a (grader)	= 15	M	= 22
B	= 31	O	= 29.6
DH7	= 25	Statisk radial belastning C0 (kN)	= 135
Dynamisk radial belastning C (kN)	= 135	Vægt (g)	= 600
F	= 94		
G	= M25x2		
GL	= 58		